

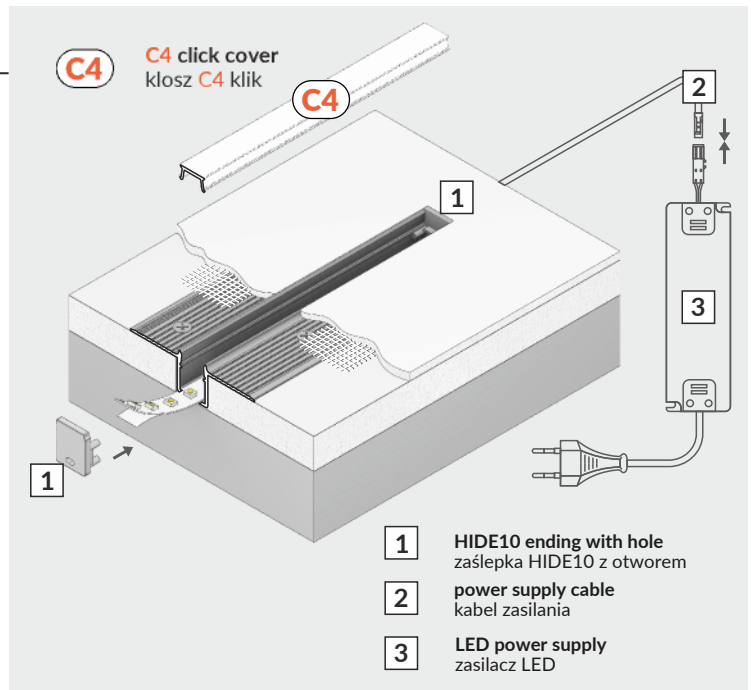

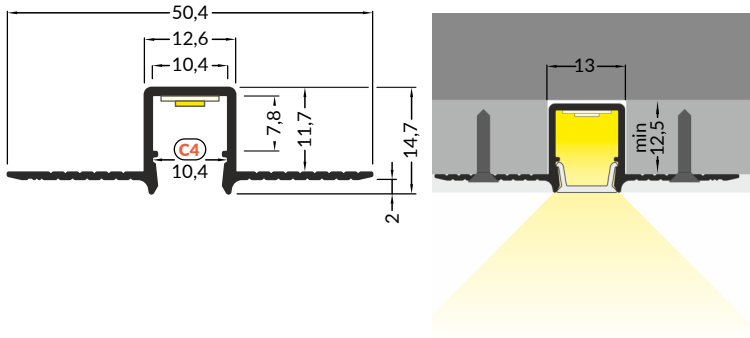





HIDE10 C4

RECESSED PROFILE / PROFIL WPUSTOWY

 max 10 mm



-  scissors
nożyczki
-  hacksaw
piłka
-  pliers
kombinerki
-  solder
cyna
-  soldering iron
lutownica
-  screwdriver
wkrętak
-  drill
wiertarka
-  spatula
szpachelka

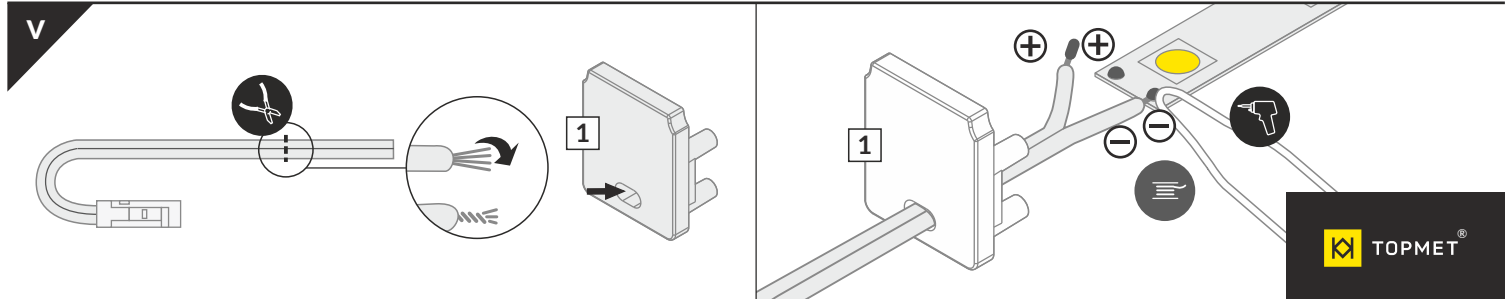
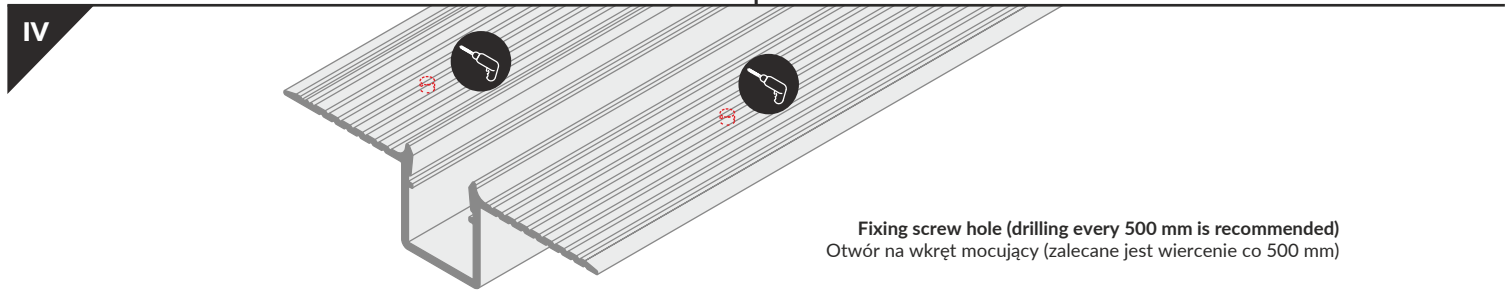
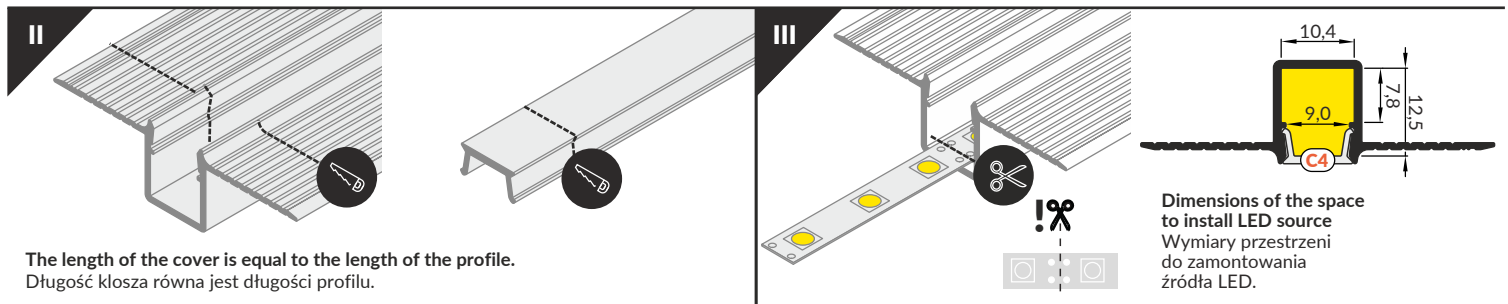
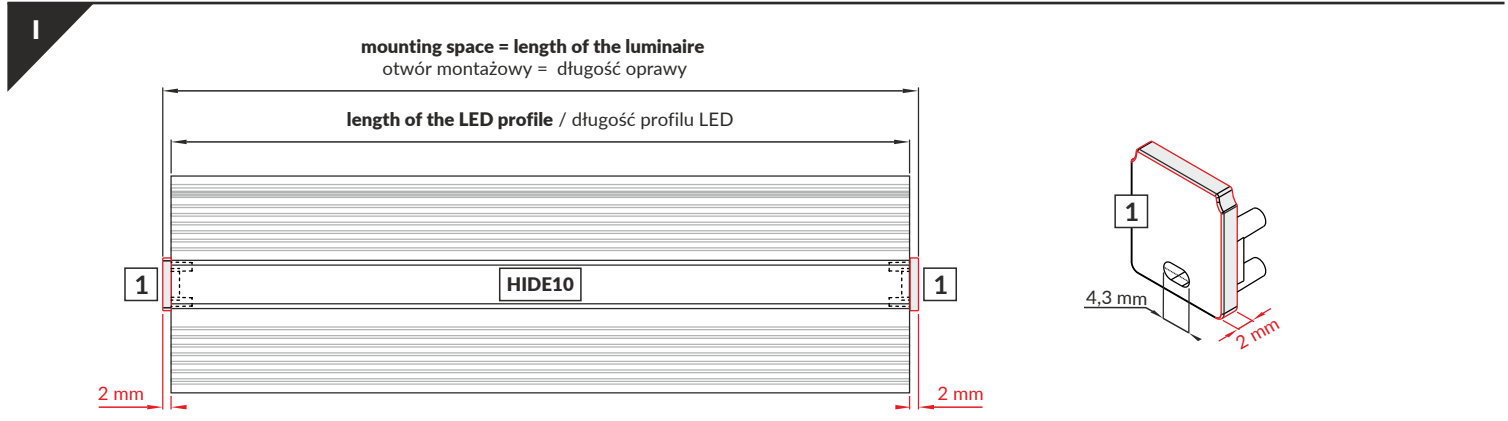

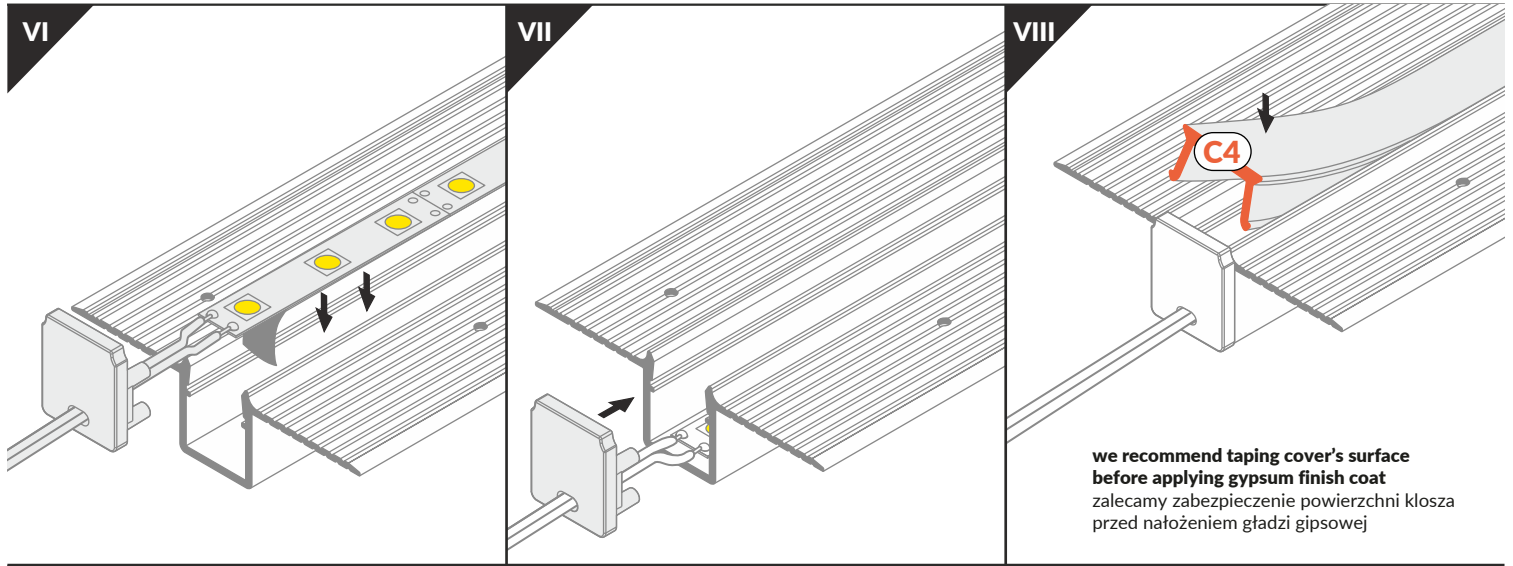

we recommend taping cover's surface before applying gypsum finish coat
 zalecamy zabezpieczenie powierzchni klosza przed nałożeniem gładzi gipsowej

IX MOUNTING / MONTAŻ

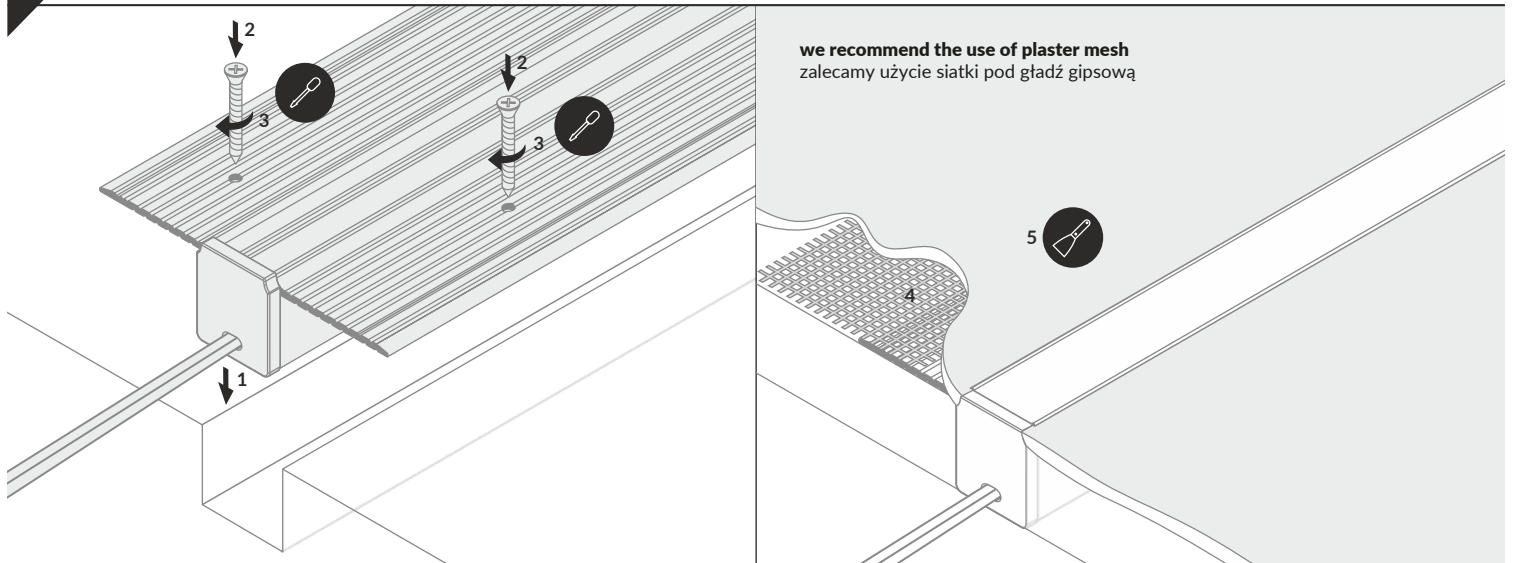

we recommend the use of plaster mesh
 zalecamy użycie siatki pod gładź gipsową

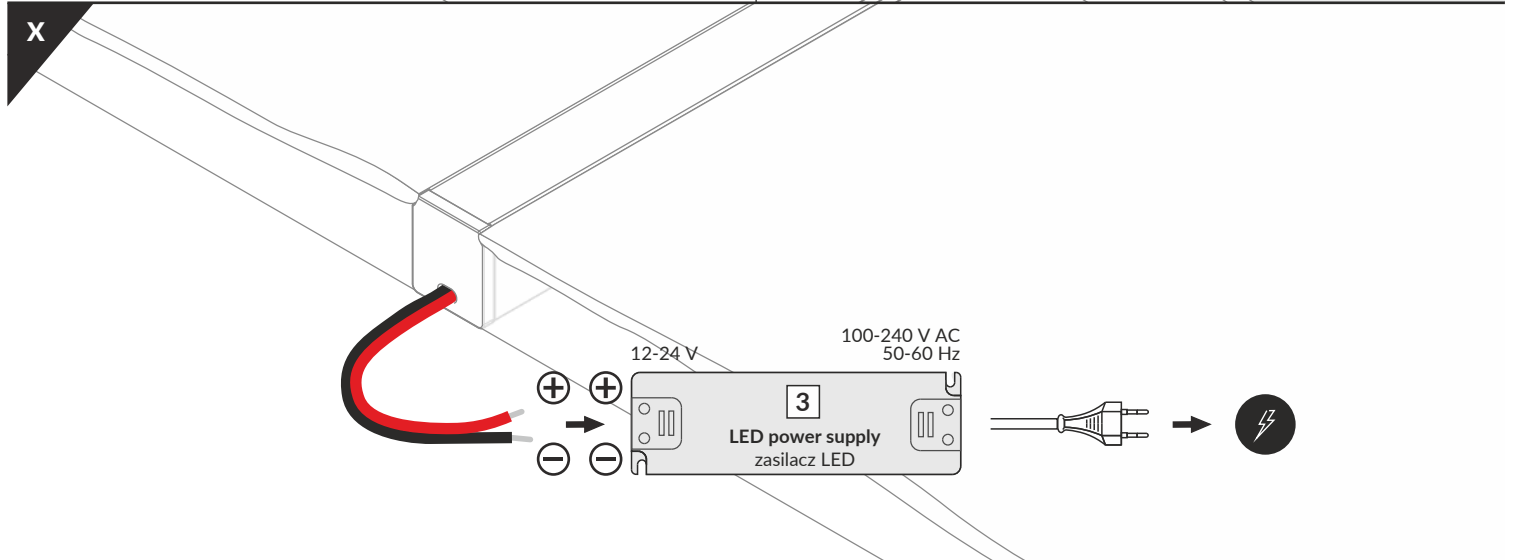

ACCESSORIES / AKCESORIA

power switches / włączniki
 controller + remote / sterownik + pilot
 movement sensors / czujniki ruchu